



## Thule Rapid System Kit 1841

# > Instructions

CITROËN DS4, 5-dr Hatchback, 11-

CITROËN DS4 **Crossback**, 5-dr Hatchback, 16-

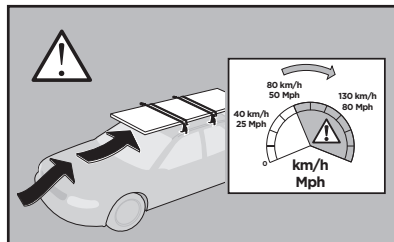
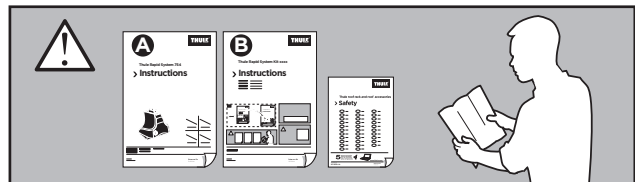
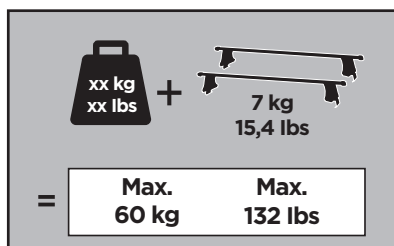
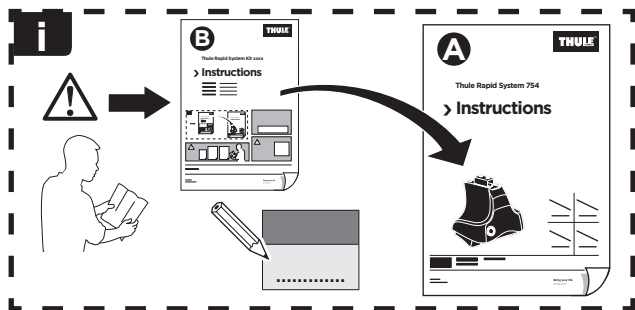

ISO 11154-E

141841  
C.20160908  
519-1841-01

Bring your life  
thule.com



167 x1

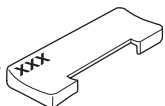

169 x1

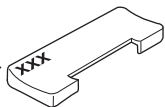

32 x2

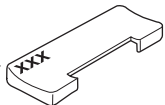

1197 x1

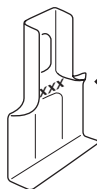

1191 x1



1190 x2

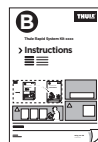

x1



x1

1

	X (scale)	X (mm)	X (inch)
<b>CITROËN DS4</b> , 5-dr Hatchback, 11-	38,5	1036	40 <sup>3</sup> / <sub>4</sub>
<b>CITROËN DS4 Crossback</b> , 5-dr Hatchback, 16-	38,5	1036	40 <sup>3</sup> / <sub>4</sub>

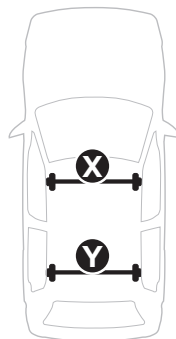
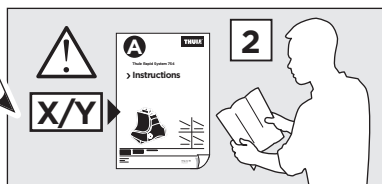
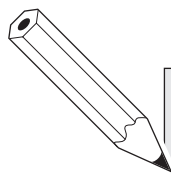

	Y (scale)	Y (mm)	Y (inch)
<b>CITROËN DS4</b> , 5-dr Hatchback, 11-	34,5	996	39 <sup>1</sup> / <sub>4</sub>
<b>CITROËN DS4 Crossback</b> , 5-dr Hatchback, 16-	34,5	996	39 <sup>1</sup> / <sub>4</sub>

**2**

**CITROËN DS4**, 5-dr Hatchback, 11-

**CITROËN DS4 Crossback**, 5-dr Hatchback, 16-

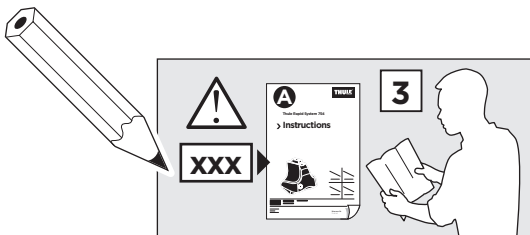
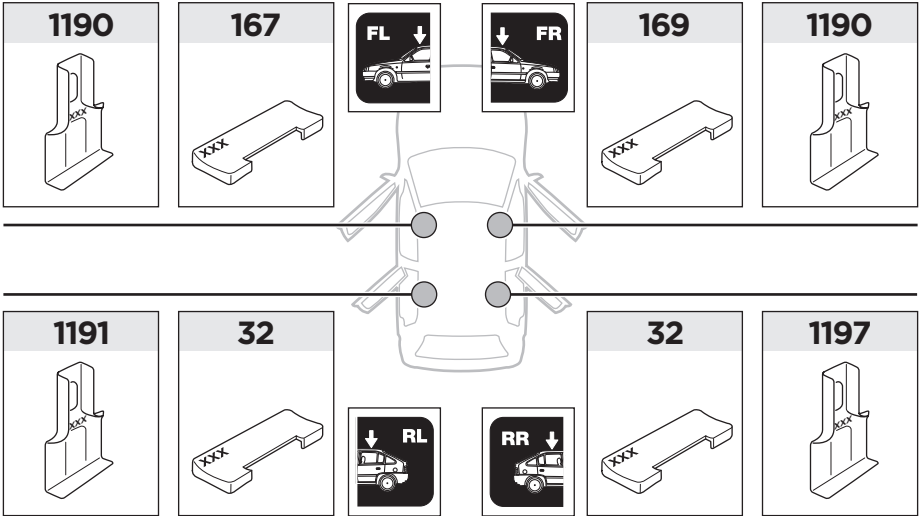

**3**



	W (mm)	Z (mm)	W (inch)	Z (inch)
<b>CITROËN DS4</b> , 5-dr Hatchback, 11-	<b>60</b>	<b>730</b>	<b>2 3/8</b>	<b>28 3/4</b>
<b>CITROËN DS4 Crossback</b> , 5-dr Hatchback, 16-	<b>60</b>	<b>730</b>	<b>2 3/8</b>	<b>28 3/4</b>

